

Anbauanleitung Seilwindenanbausatz *Installation instruction winch mounting kit* Toyota Landcruiser J 200

Best.-Nr.: 16 - 5890

AL: 1183 – 02



**Hier sehen sie den fertig montierten Seilwindenanbausatz.
Bevor sie mit der Montage beginnen, lesen sie bitte diese Anleitung
und das Benutzerhandbuch der Seilwinde gut durch.**

Achtung:

Bei Fahrten im öffentlichen Straßenverkehr muß das Rollenseilfenster mit einer Kunststoffabdeckung abgedeckt werden.

Before you start fitting ,please read and understand this instruction manual and the owners manual of the winch.

Stückliste – parts list

Seilwindenanbausatz – winch mounting kit

Toyota J 200

Best.nr.: 16 - 5890

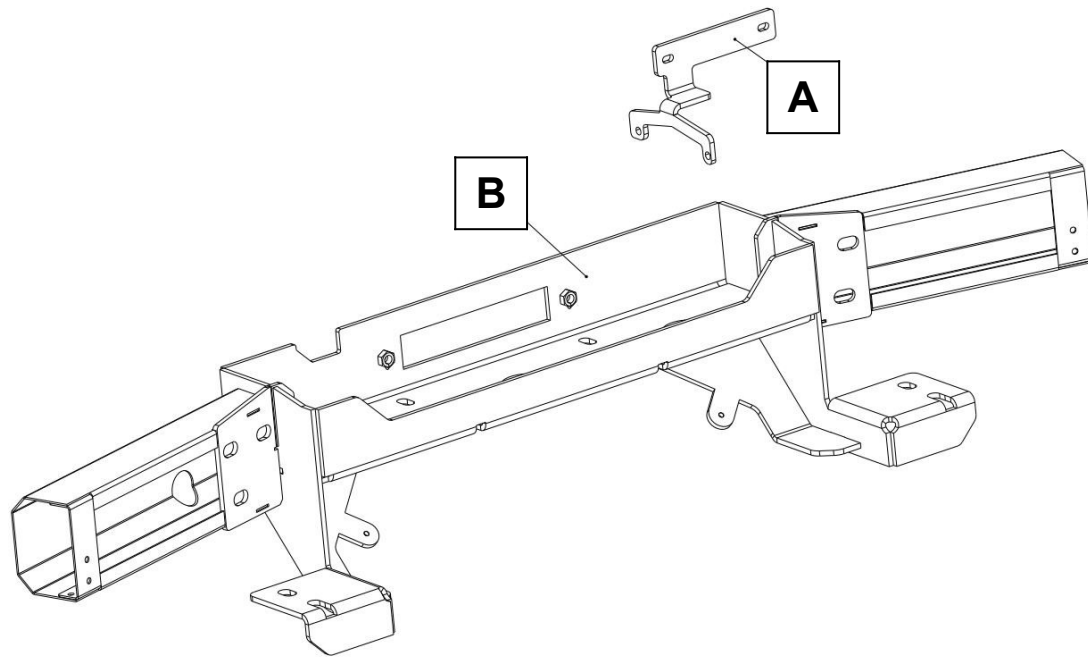

1 x Schaltkastenhalter (A)
1 x Seilwindenträger (B)

1 x Anleitung AL 1183
1 x Gutachten

8x Schraube M 6 x 20
10 x U – Scheibe M 6 x 20
6 x U – Scheibe M 6 x 30
6 x Federring M 6
6 x Mutter M 6

2 x Schraube M 10 x 25
2 x Federring M 10
2 x U - Scheibe M 10



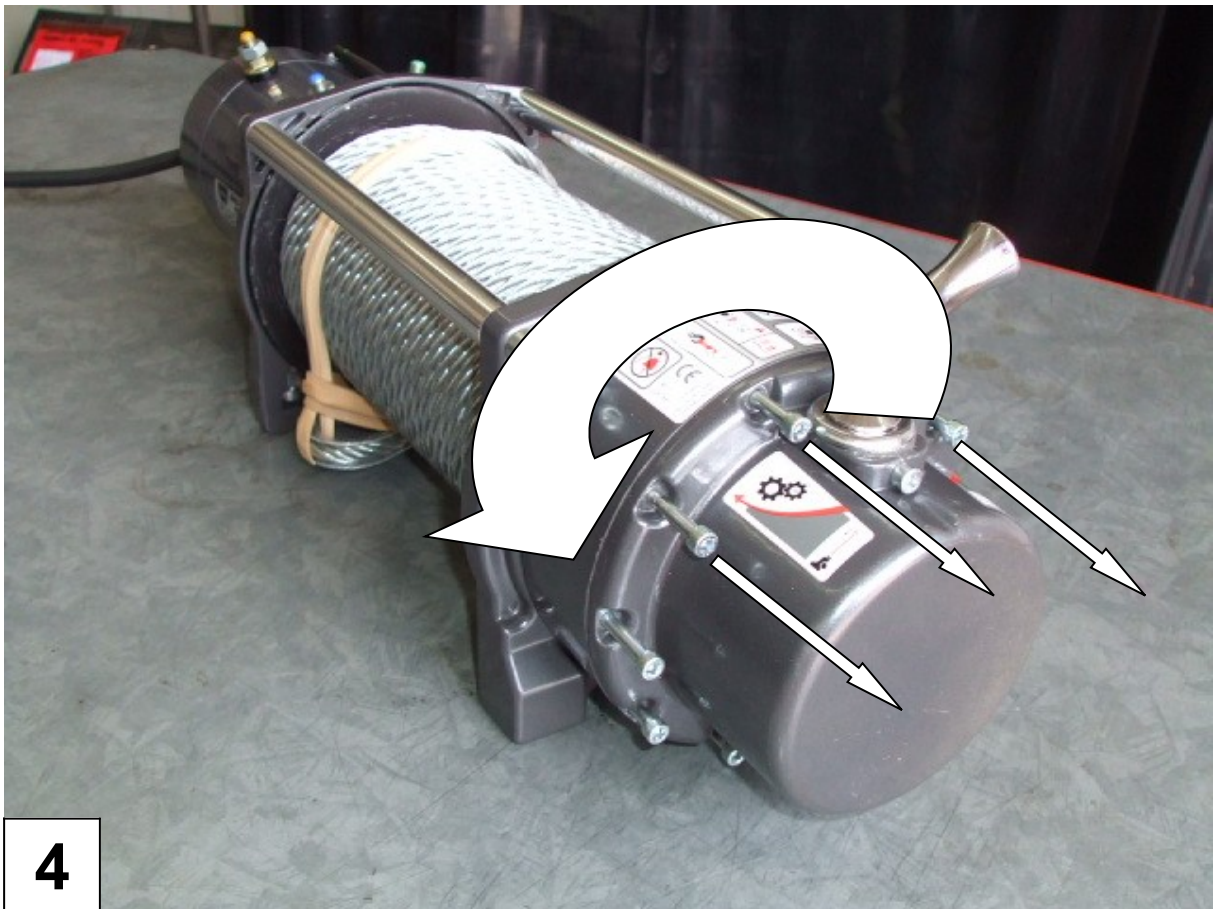

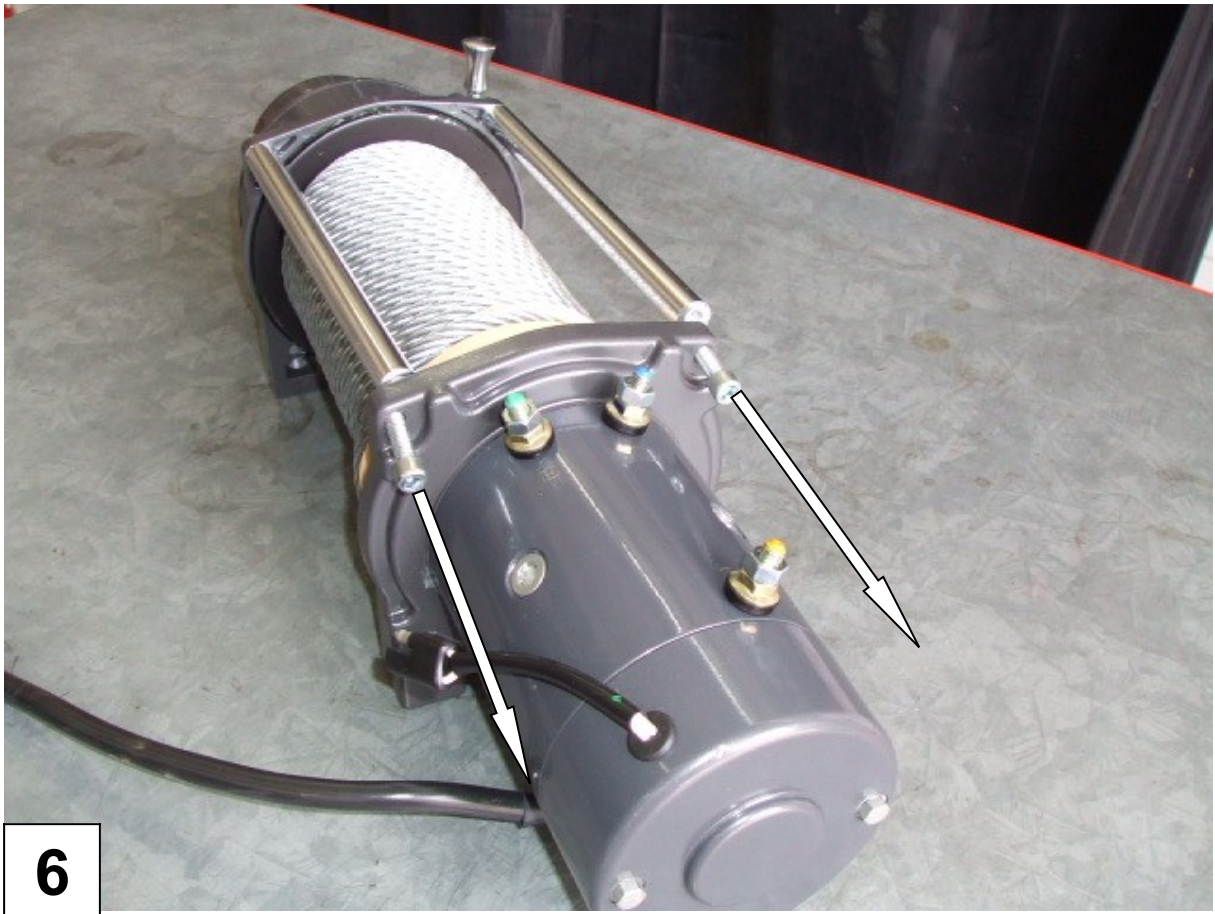
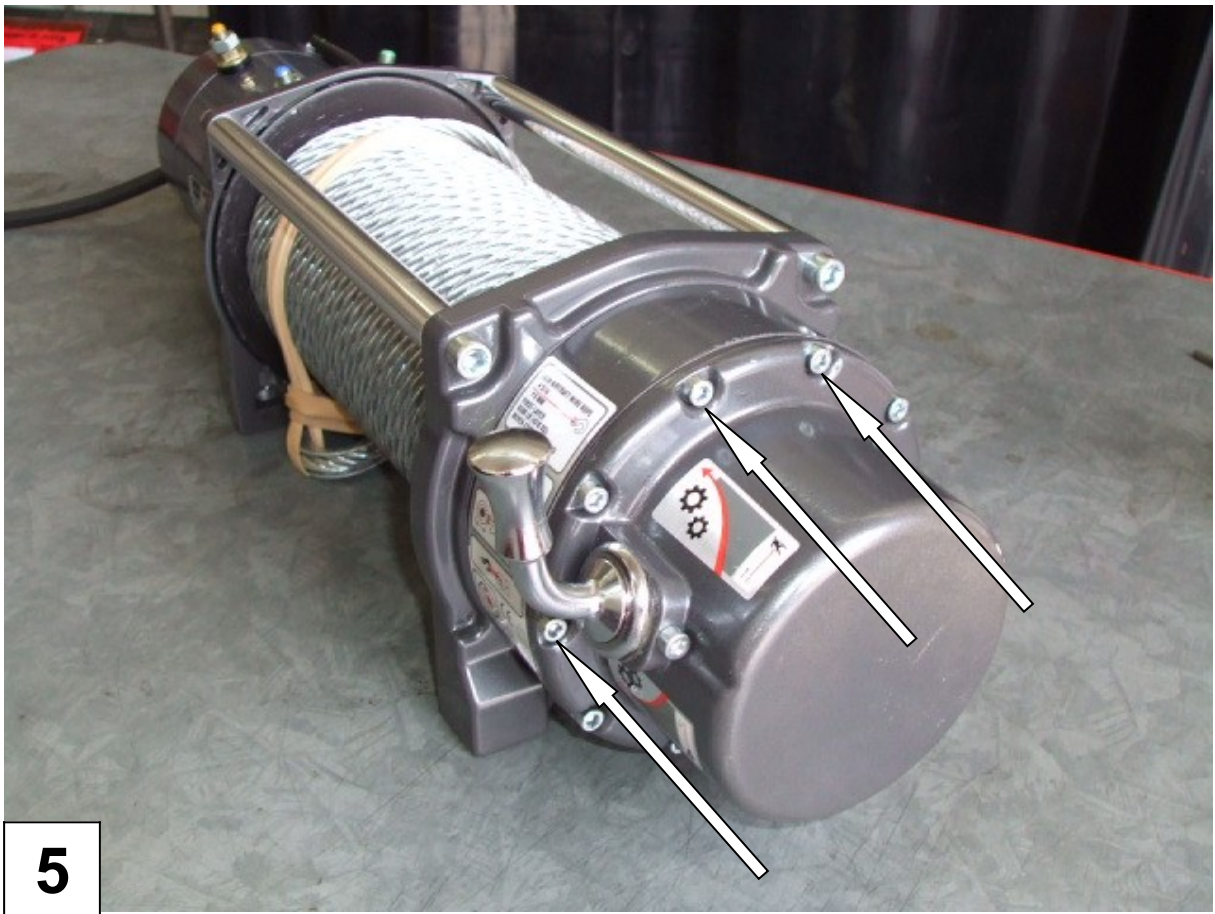

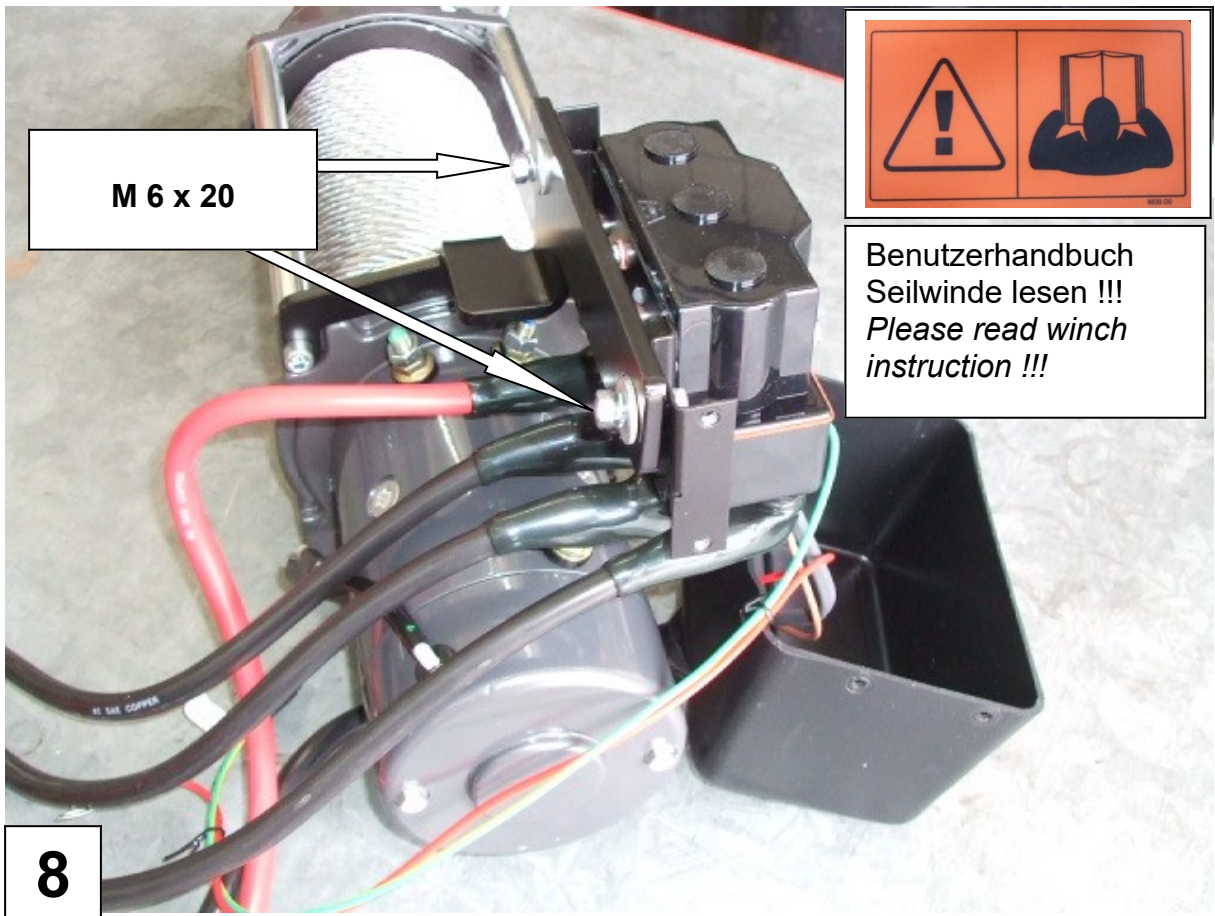
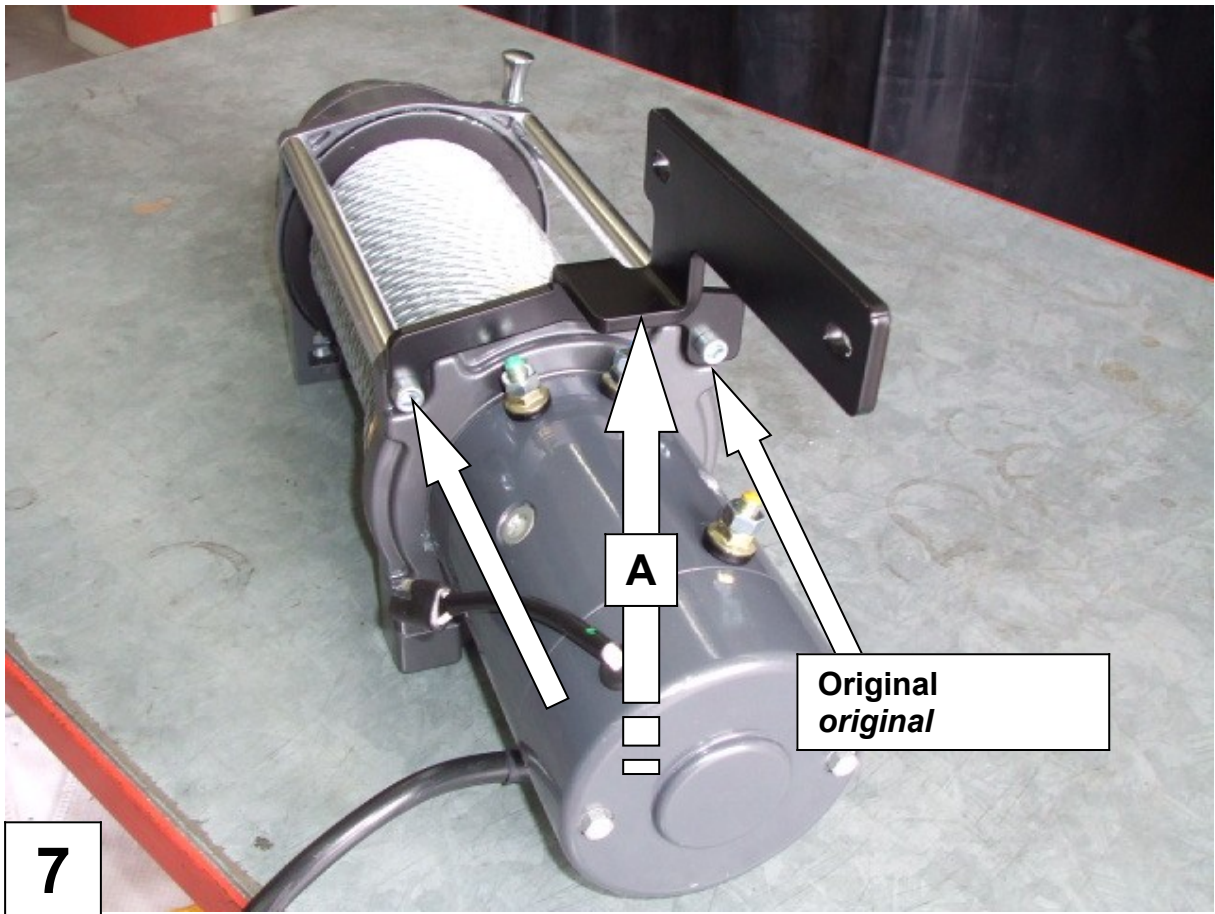

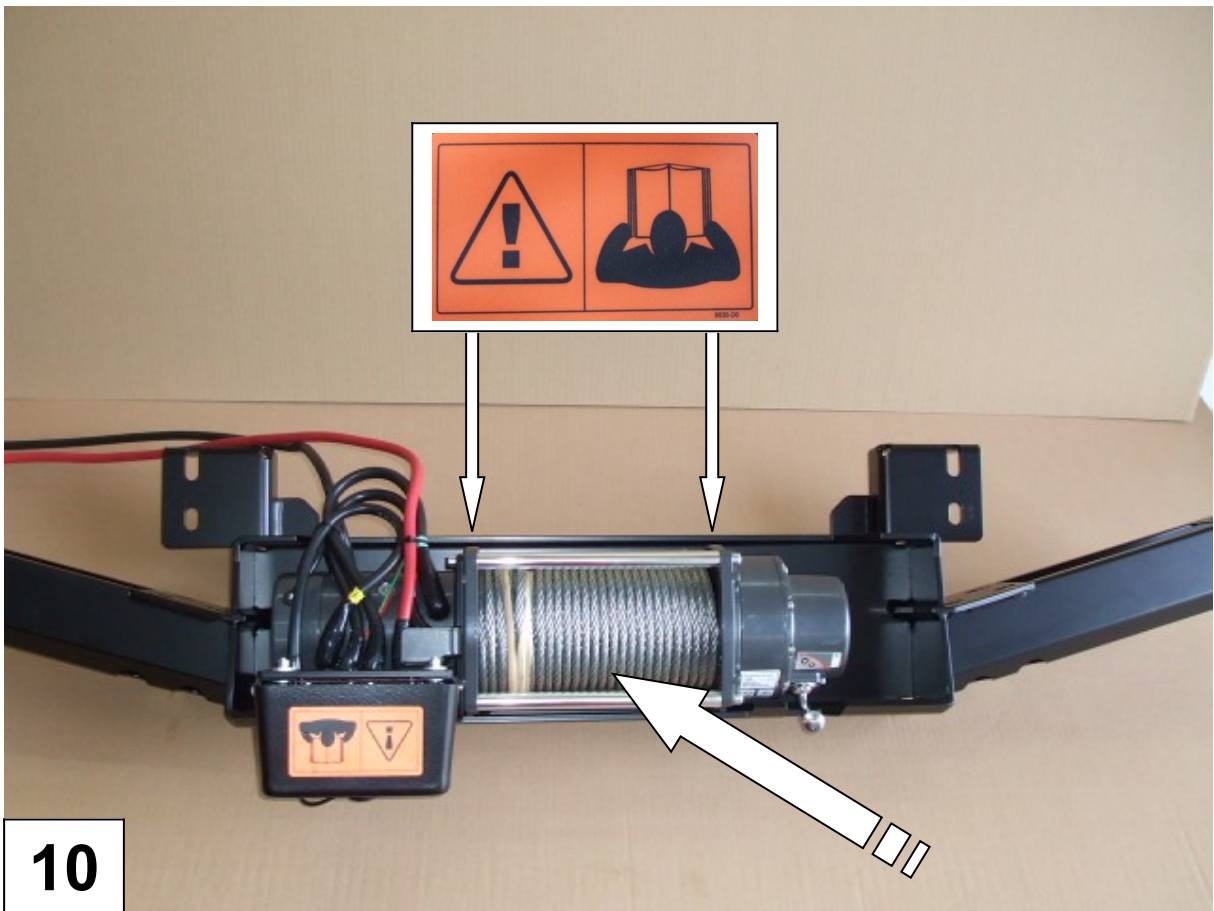
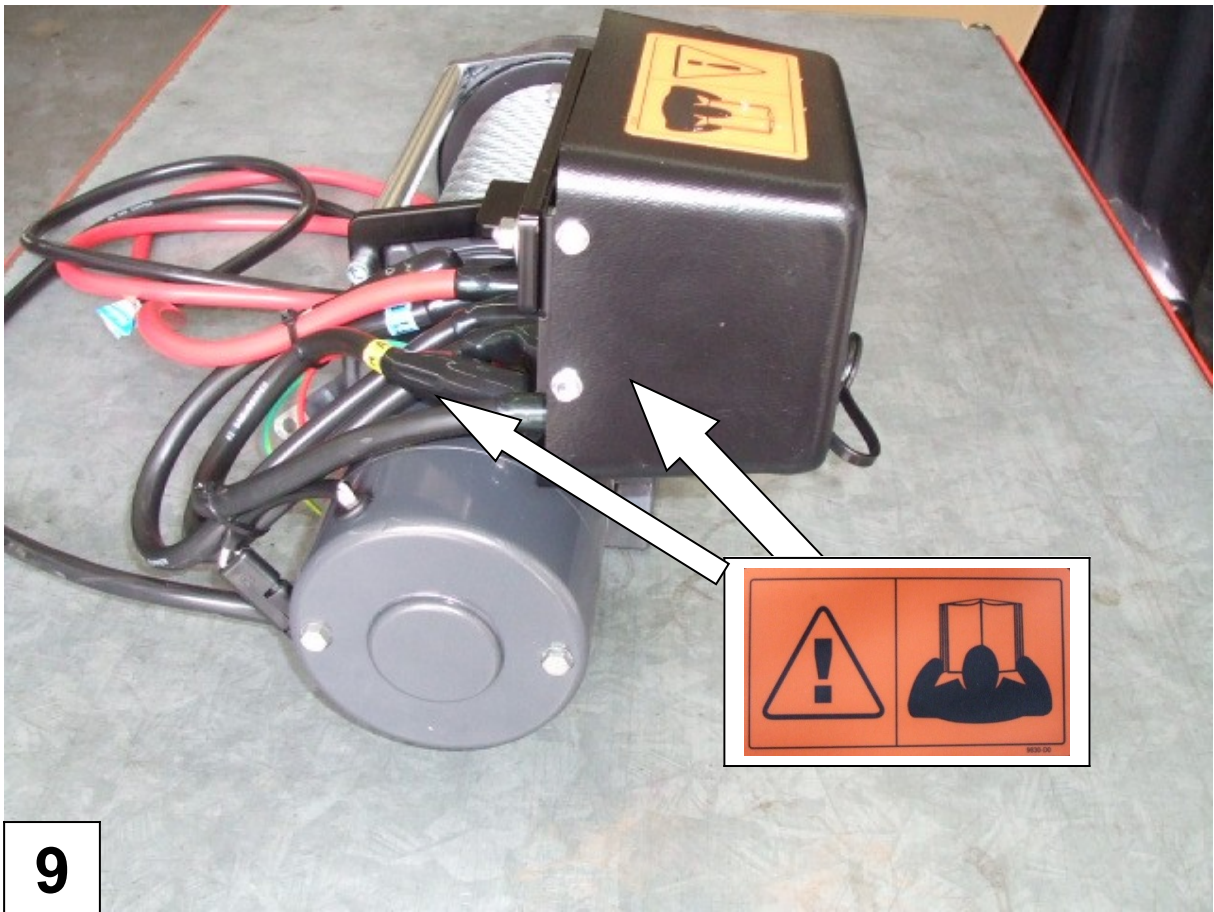

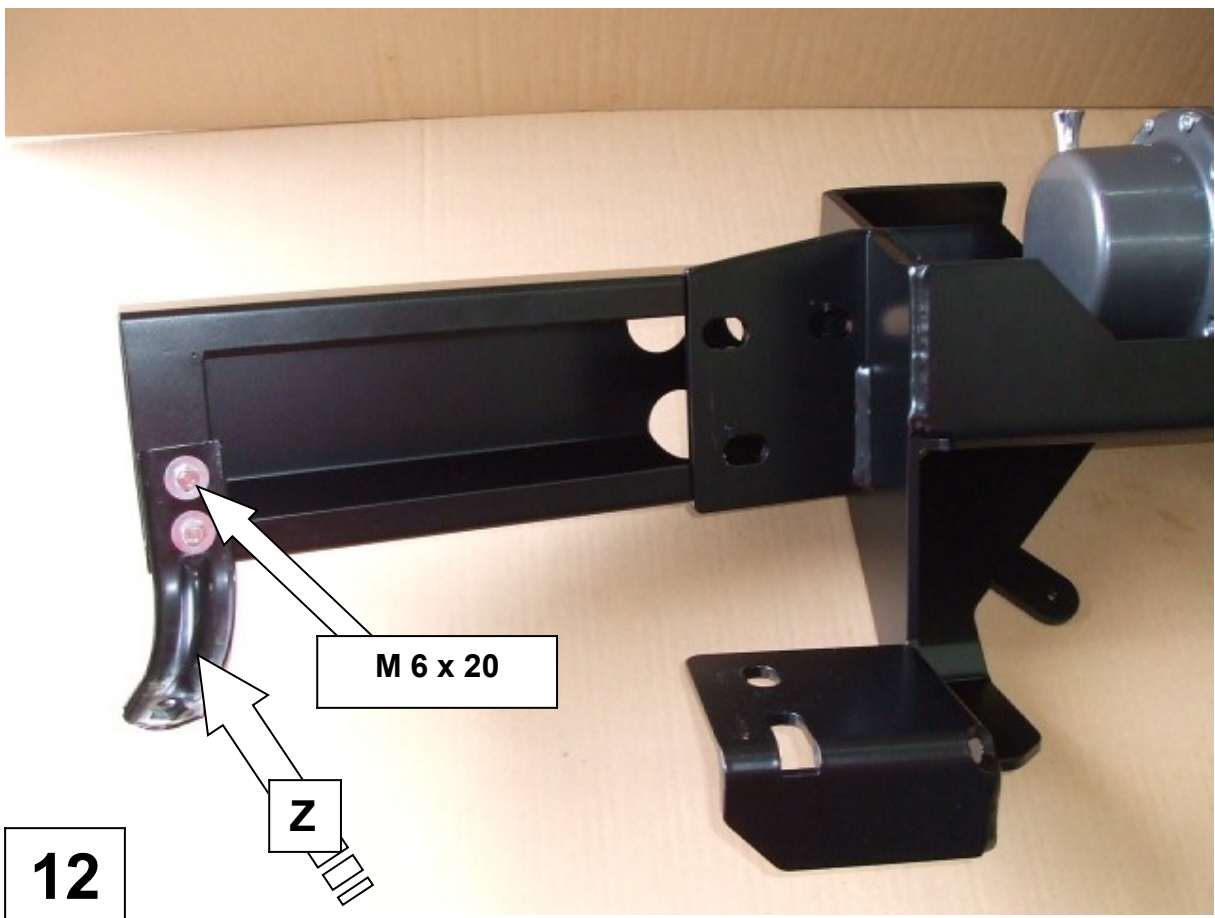
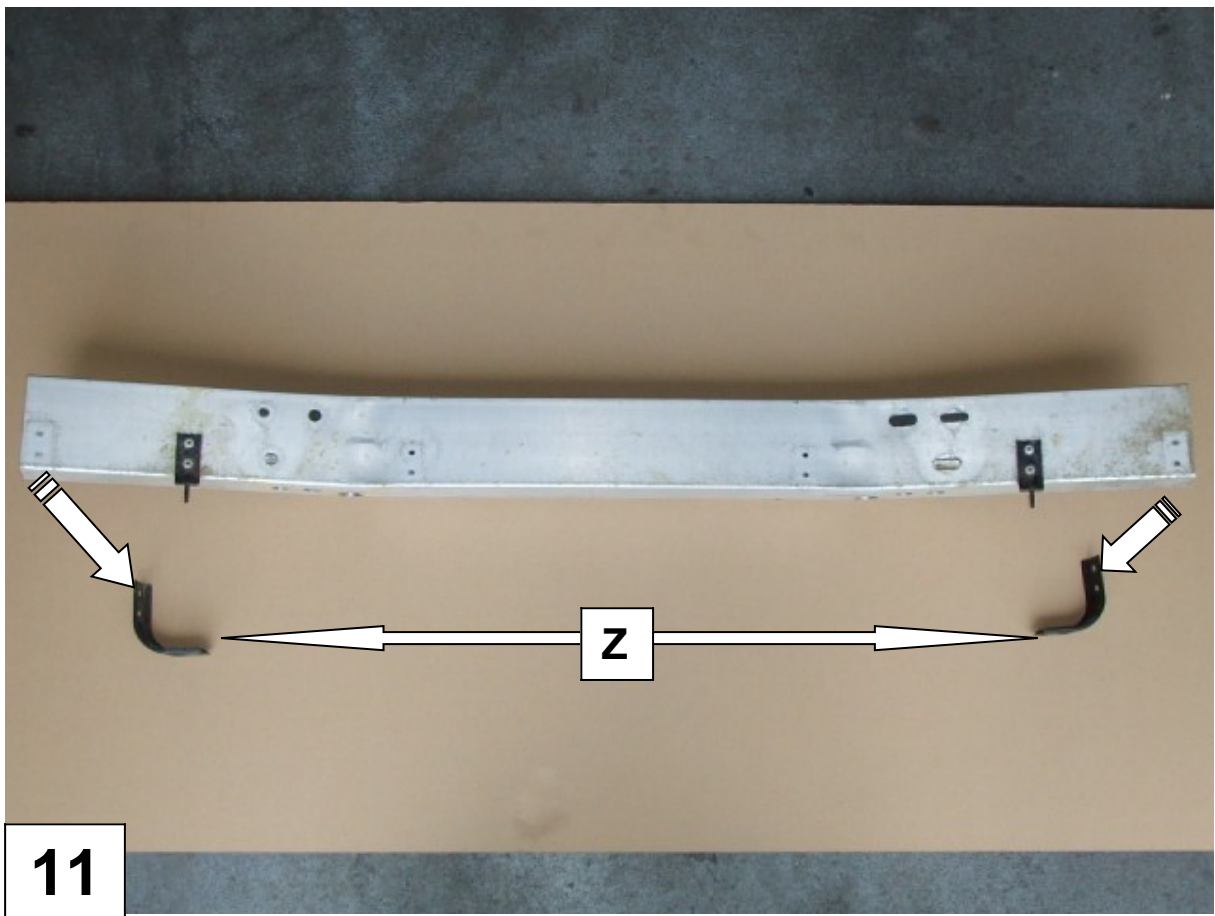



13

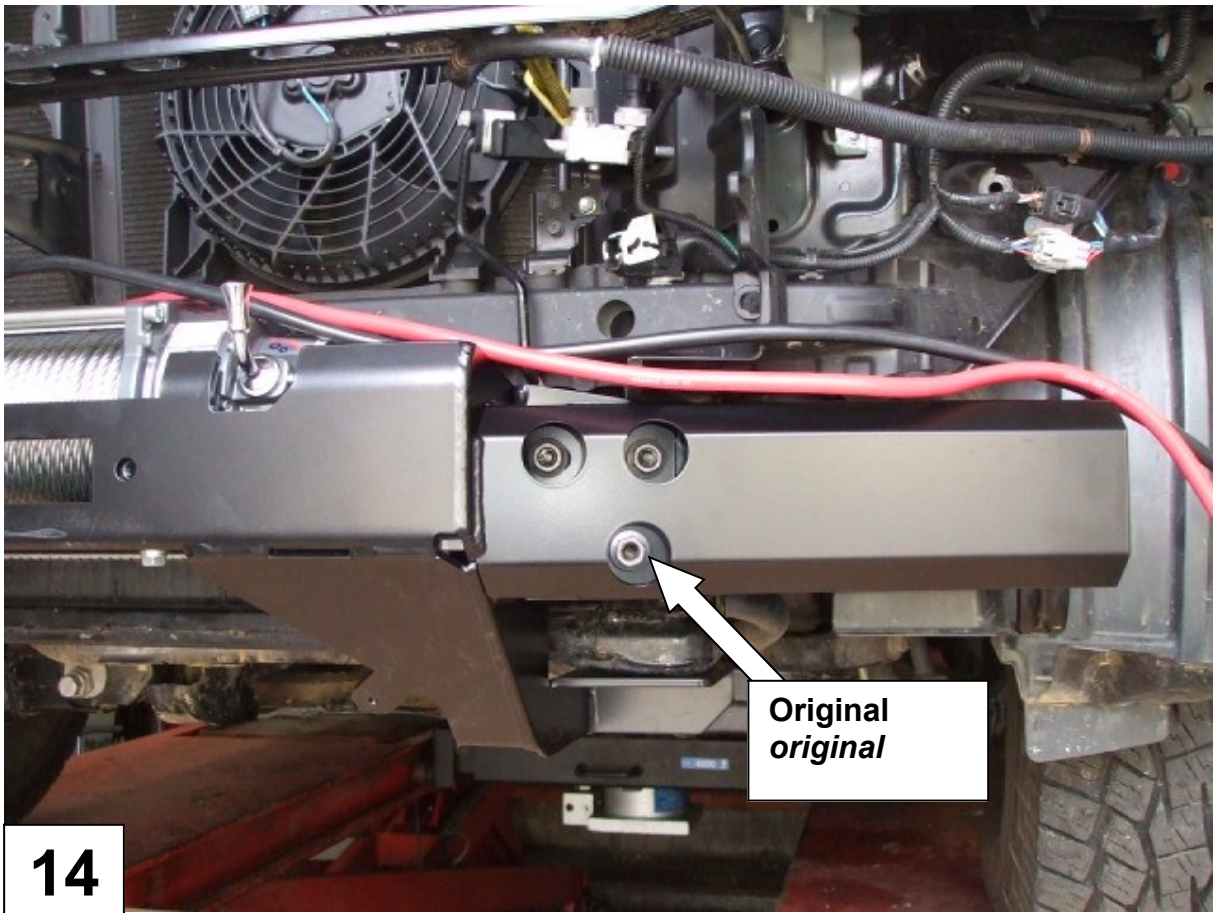

Original
original

14

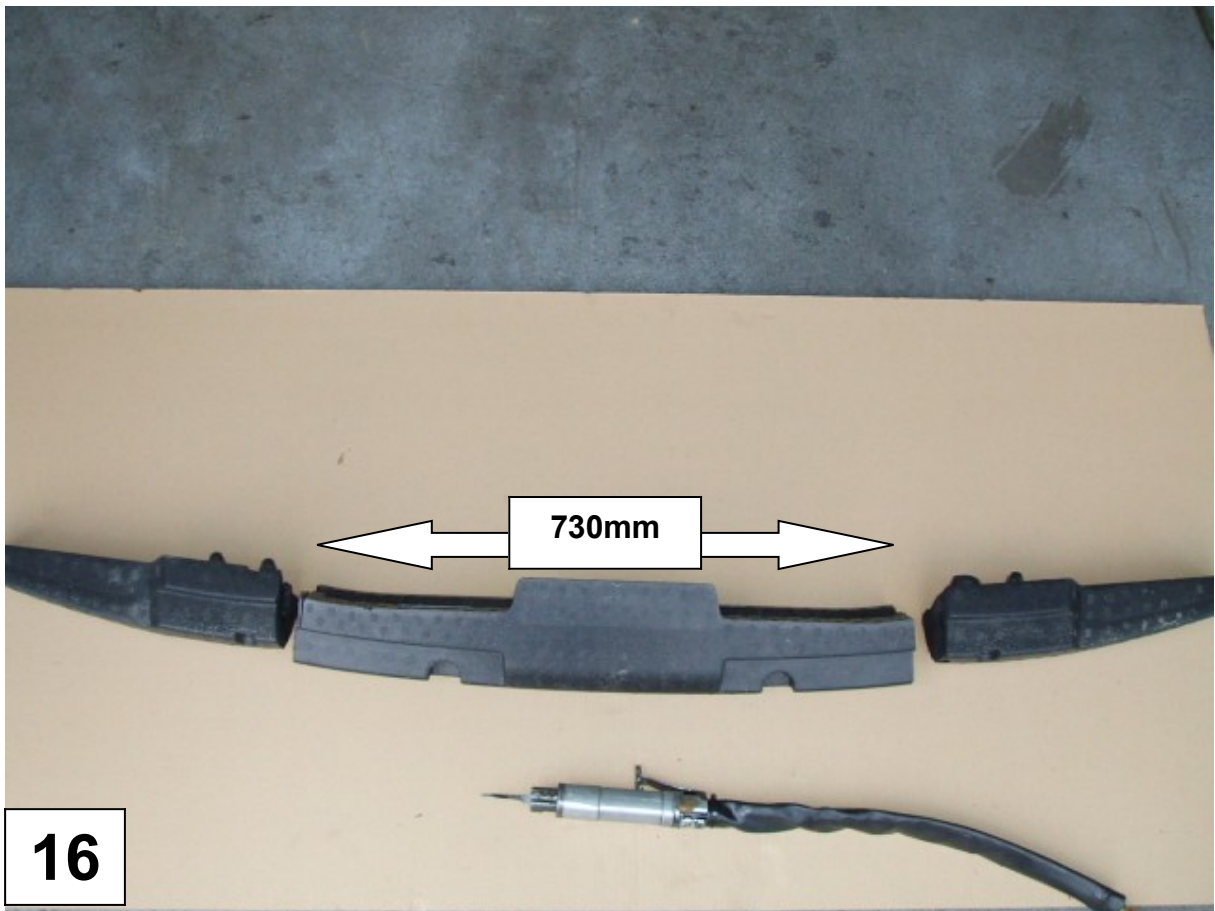
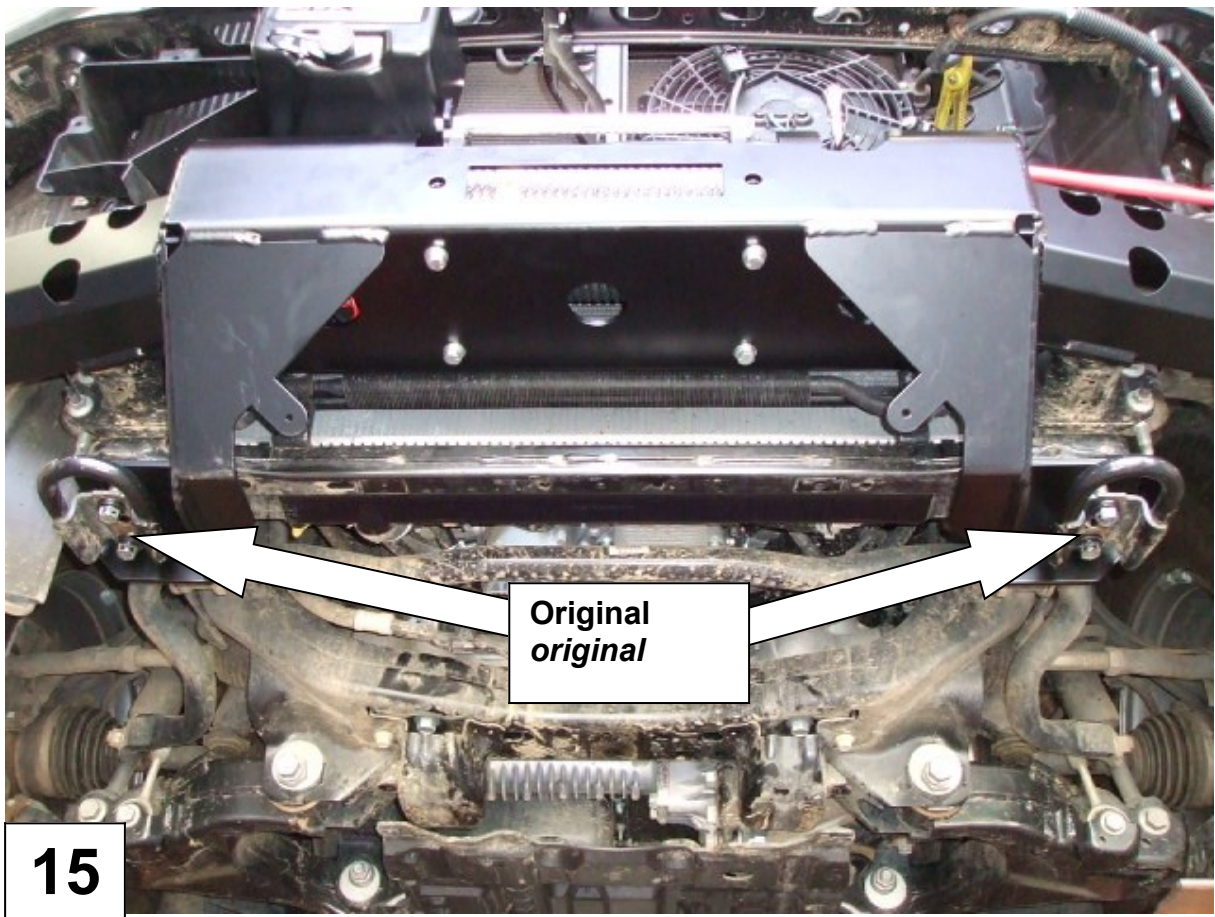

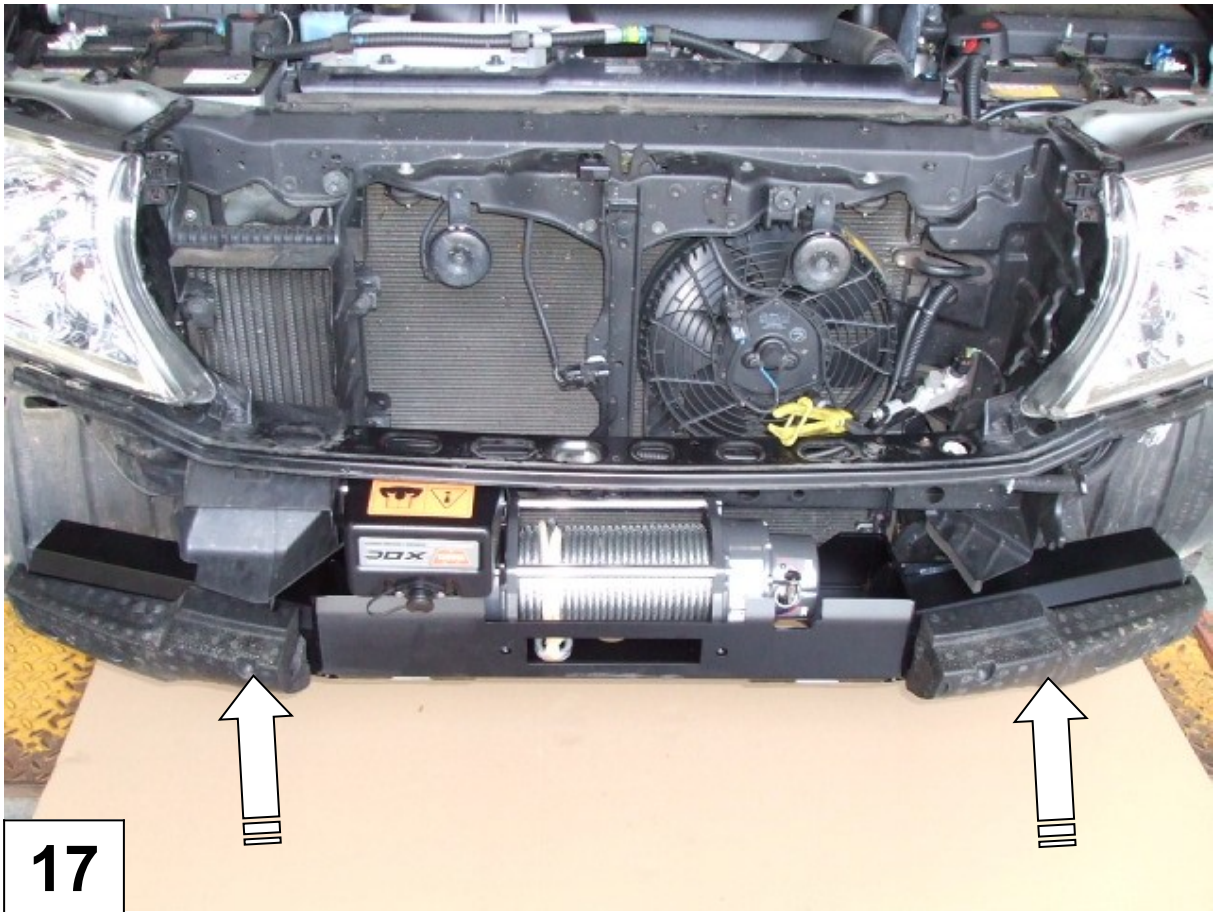

17

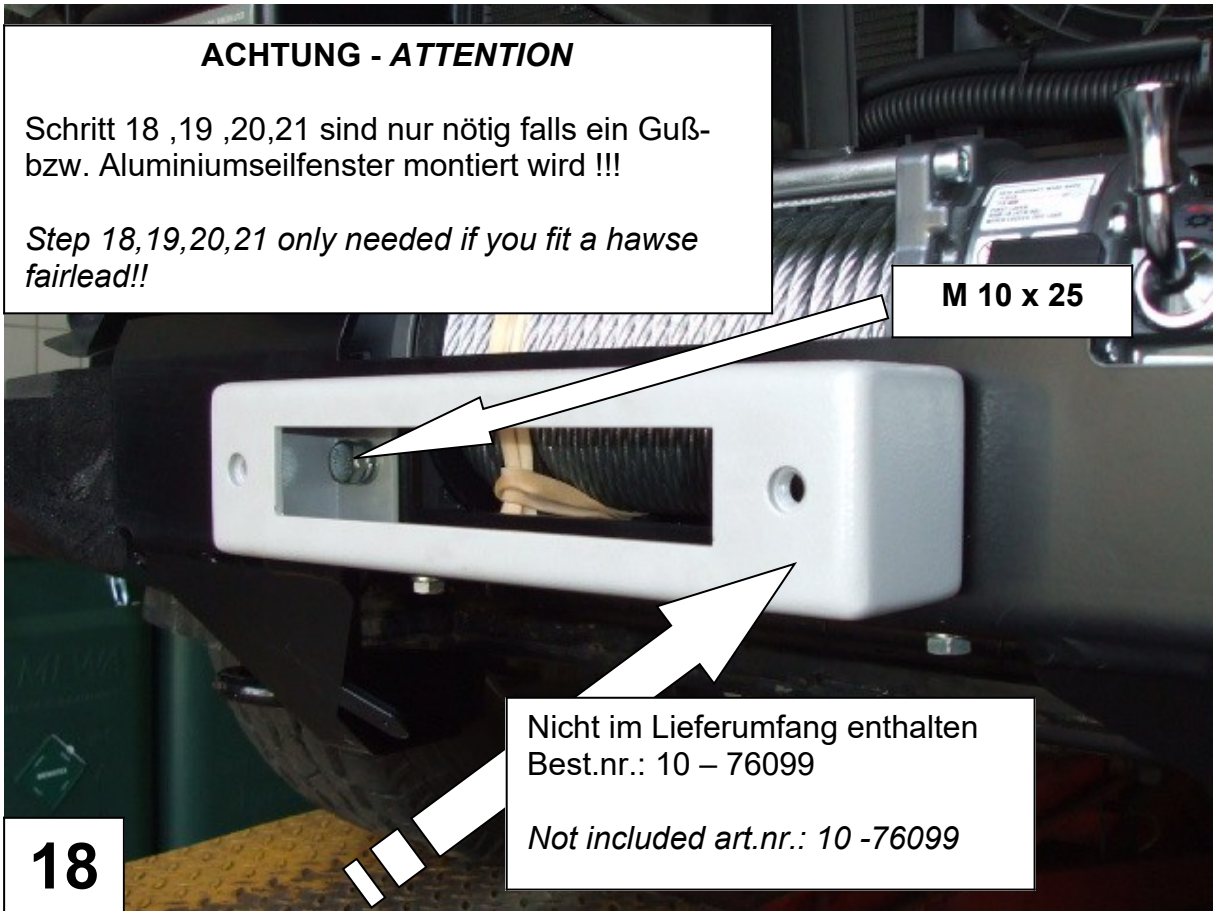

ACHTUNG - ATTENTION

Schritt 18 ,19 ,20,21 sind nur nötig falls ein Guß- bzw. Aluminiumseilfenster montiert wird !!!

Step 18,19,20,21 only needed if you fit a hawse fairlead!!

M 10 x 25

Nicht im Lieferumfang enthalten
Best.nr.: 10 - 76099

Not included art.nr.: 10 -76099

18

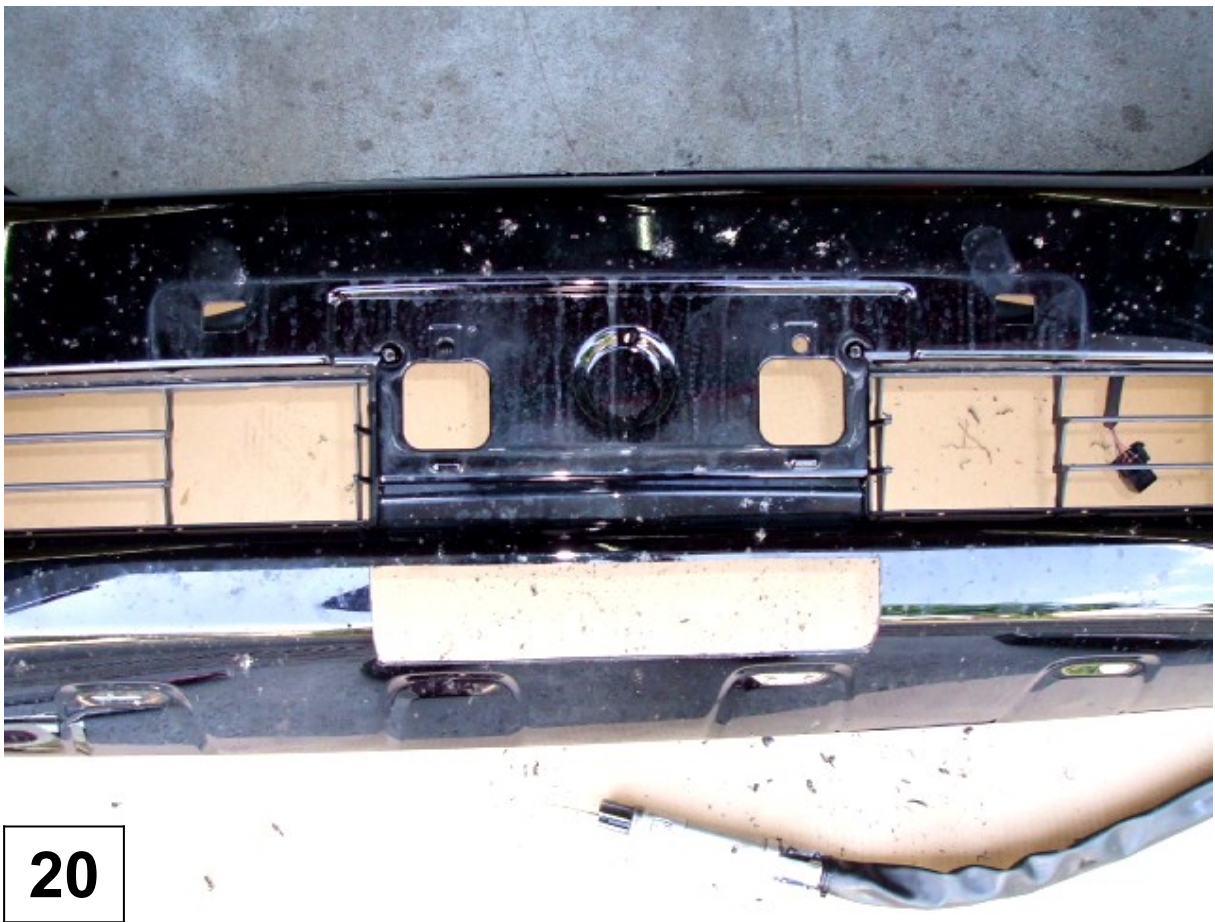
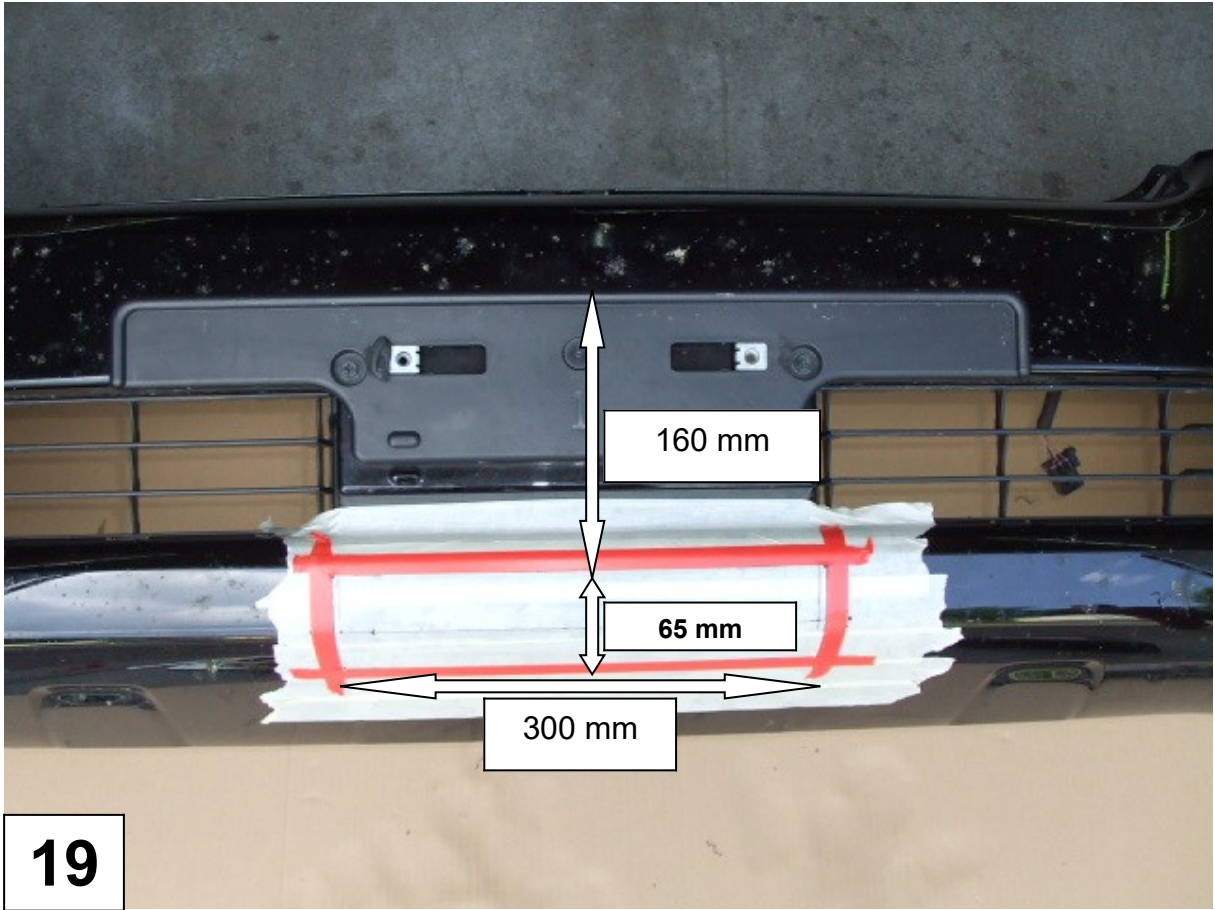

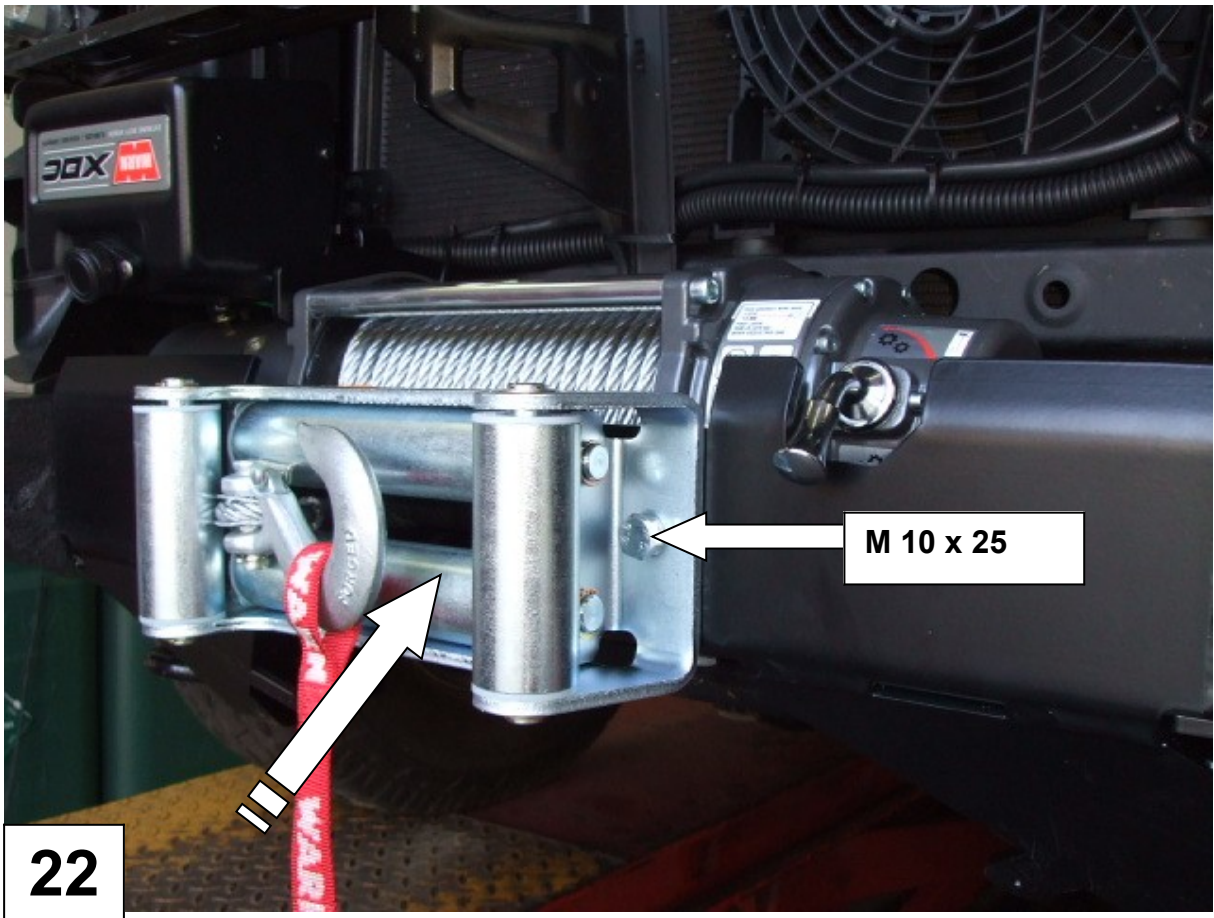

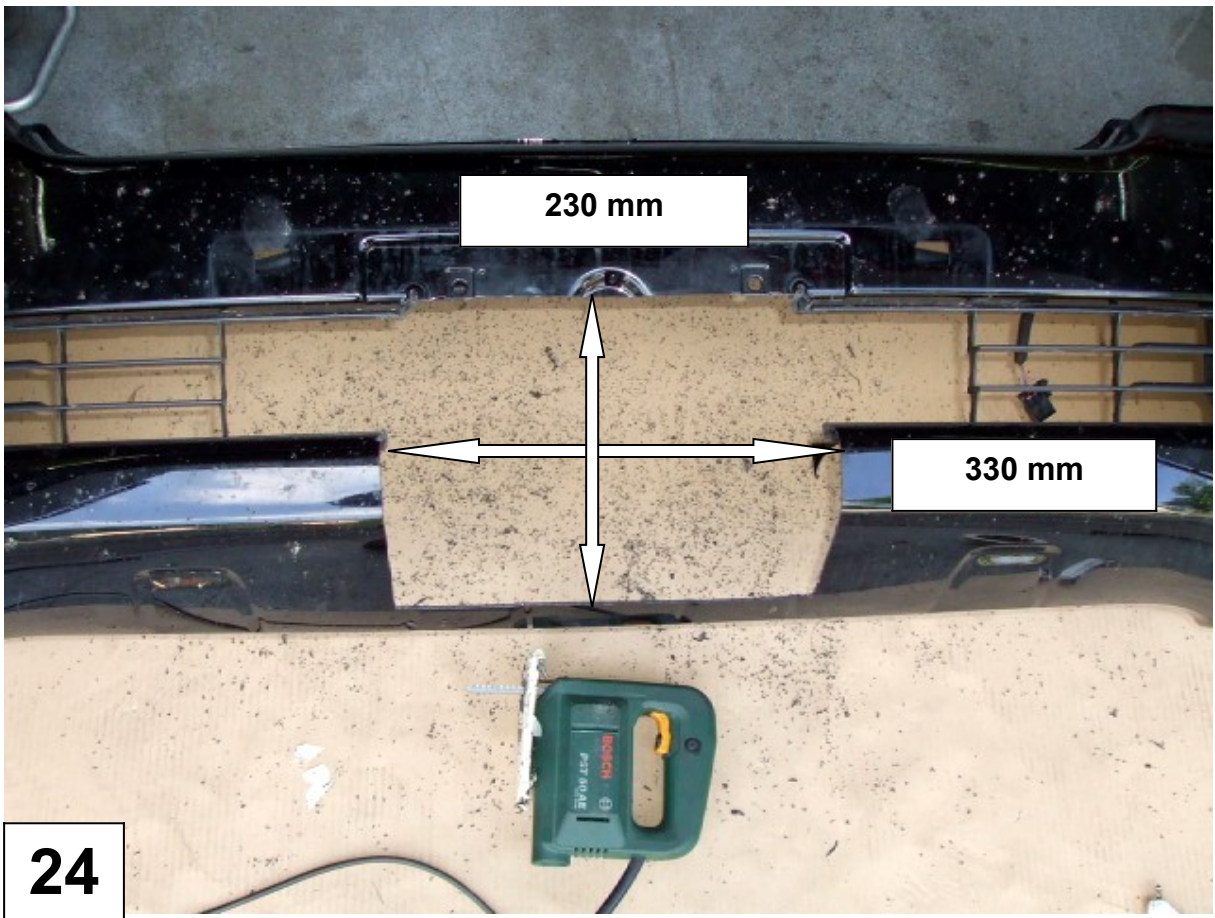
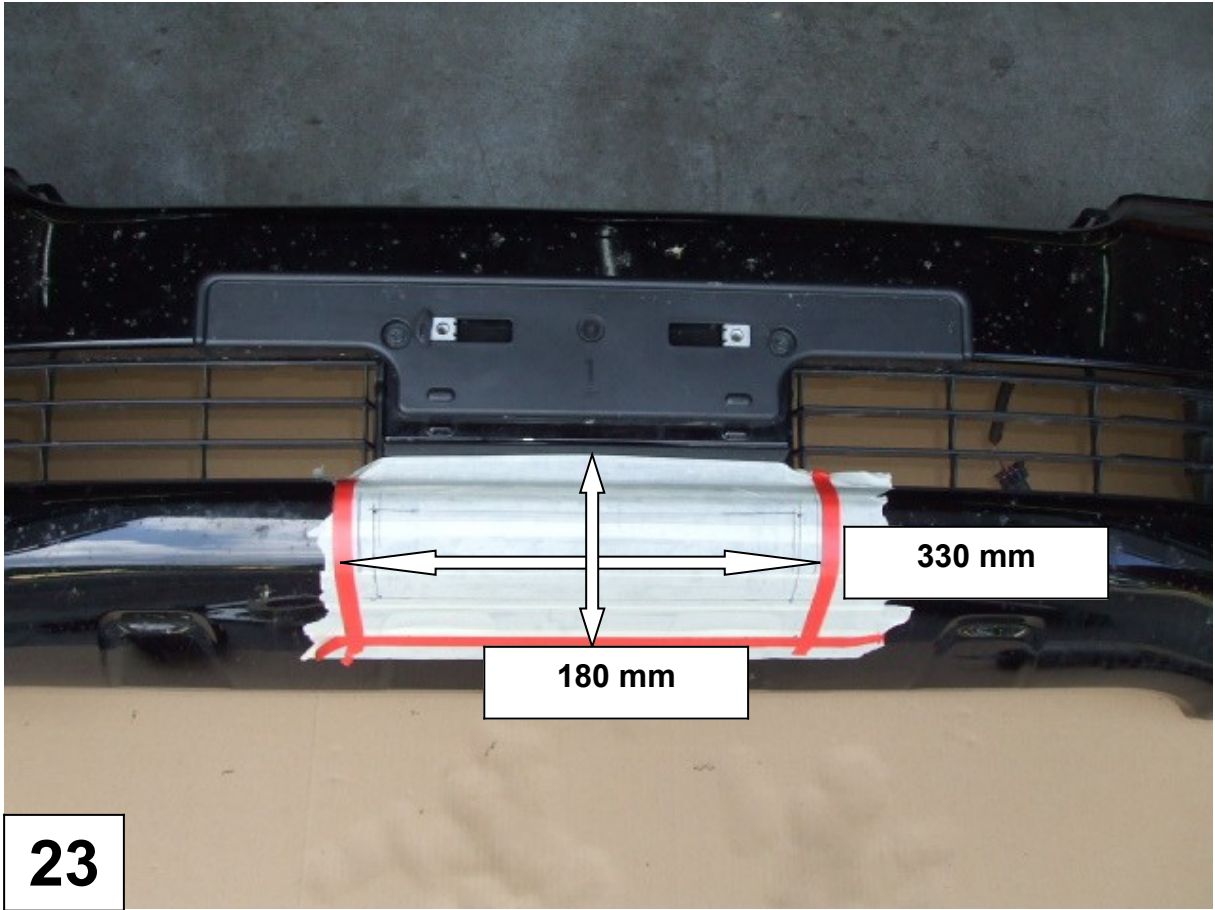

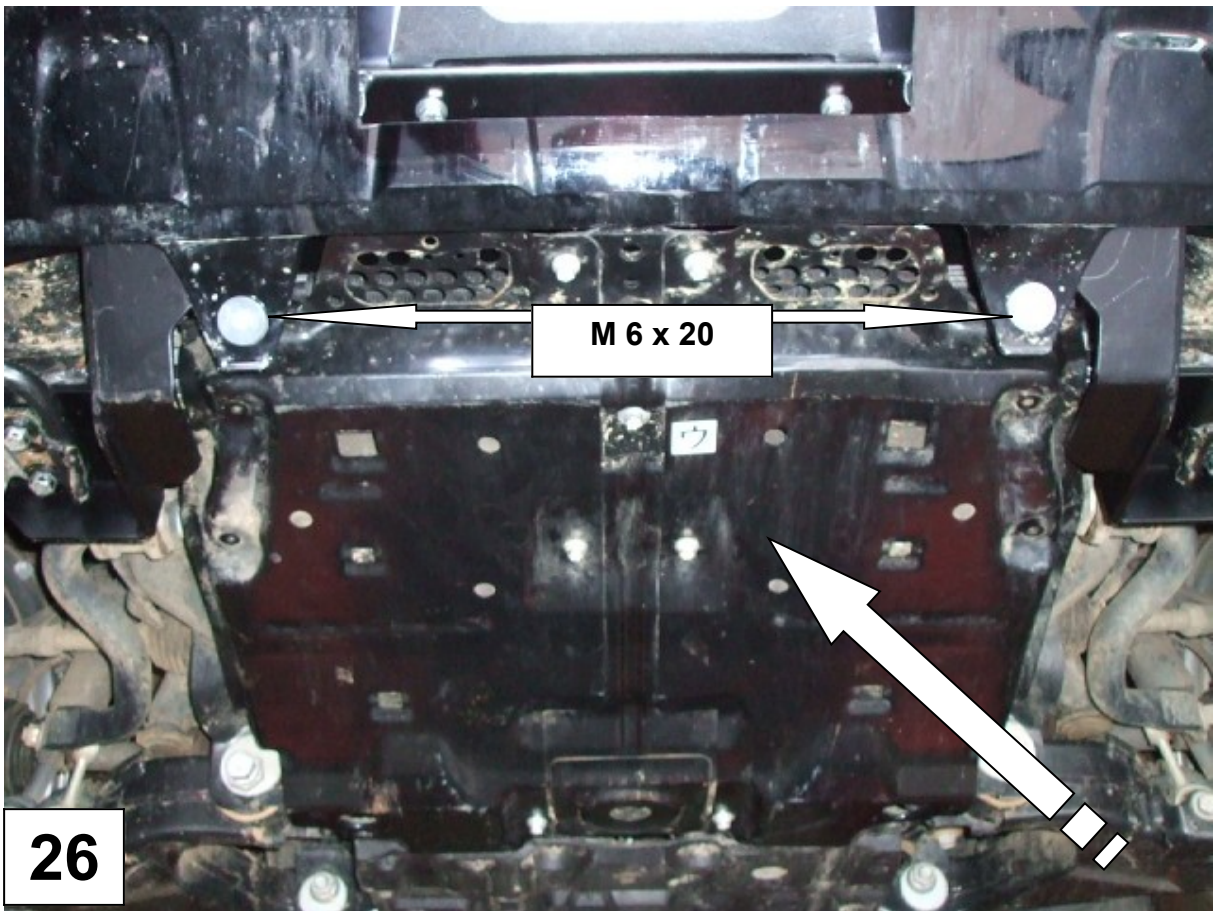



27

Fertig !!!

Ready !!!